

4403008241_20130513

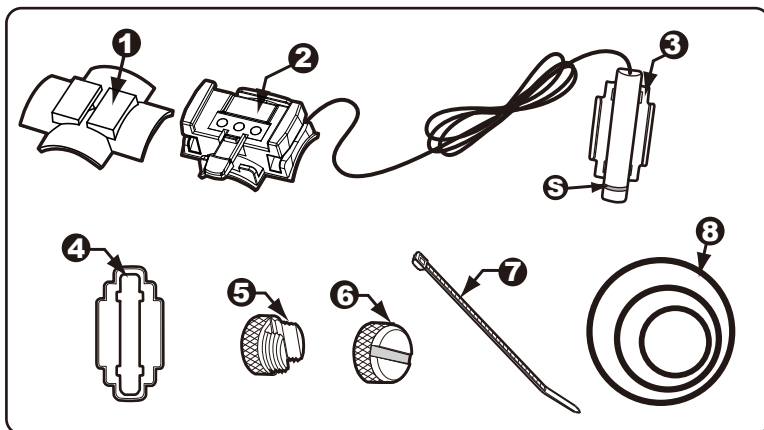

托架安裝 A. 安裝在立管上

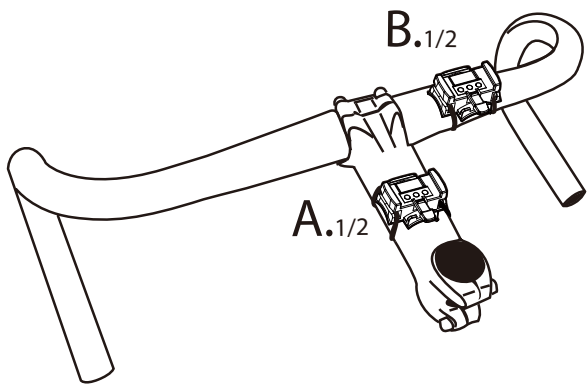
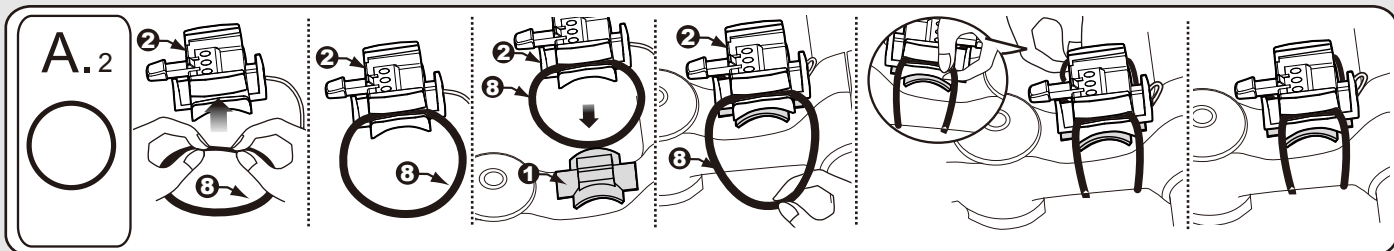
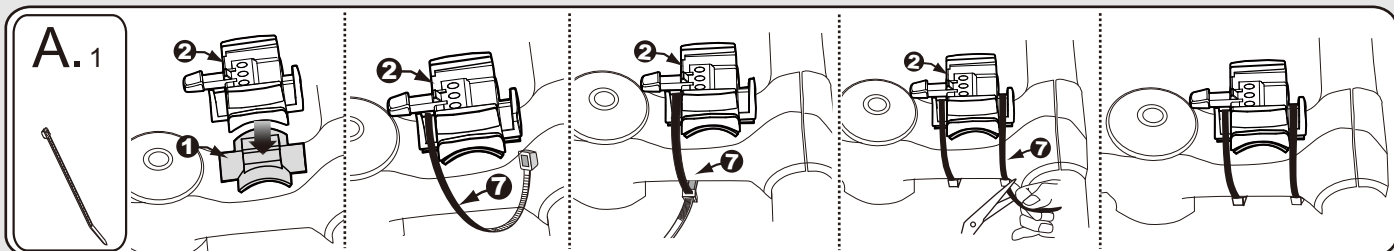

托架安裝 B. 安裝在把手上

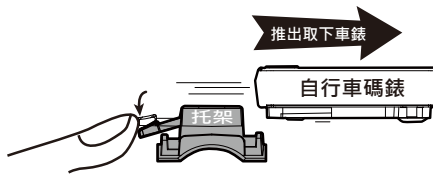
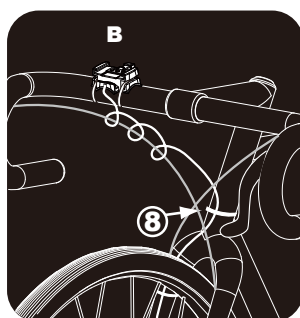
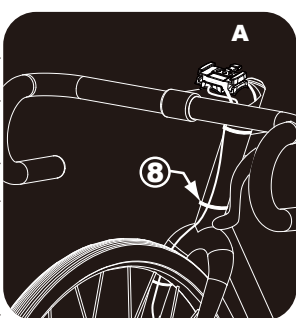
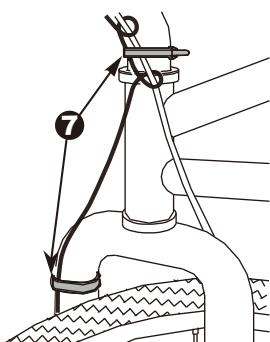
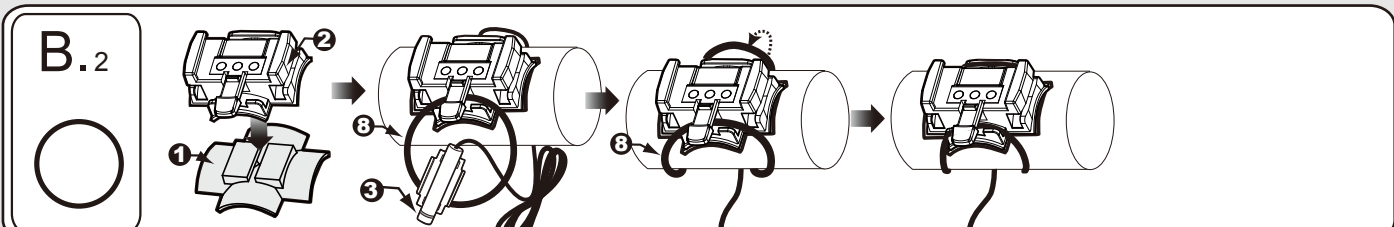
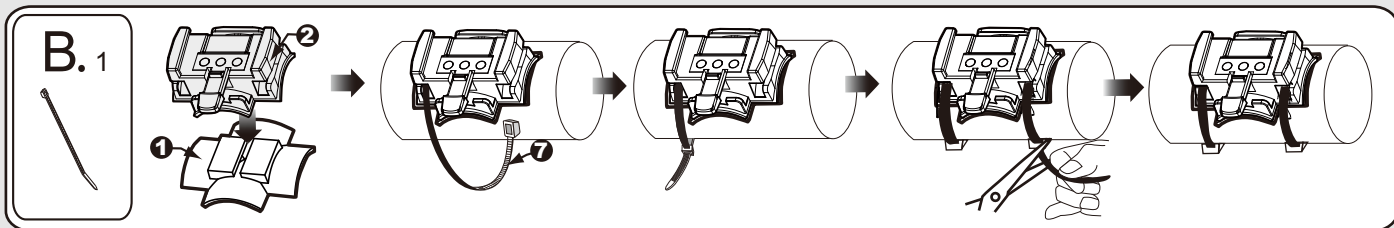

4403008241_20130513

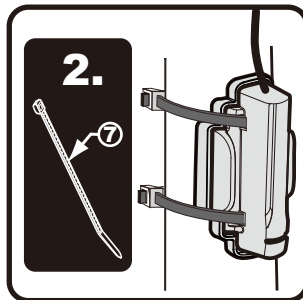
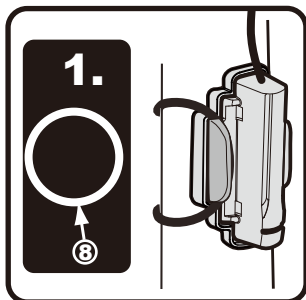

C. 有線速度感測發射器及磁鐵座安裝

