

Index

- Wheel Circumference Measurement _____ 01.
- Button function description _____ 02.
- Data setting _____ 03~06.
- LCD (icon) display _____ 07.
- General function Display _____ 08~09.
- General Mode Display _____ 10.
- Sensor pairing _____ 11.
- Functions(SPEED) _____ 12~13.
- Functions(RPM) _____ 14~15.
- Functions(Temperaur) _____ 15.
- Functions(CO₂) _____ 15~16.
- Functions(Others) _____ 16~17.
- Maintenance Reminder/
About Pedal Revolution /
About RPM Limit _____ 18.
- About LAP(for Ui35 only) _____ 19.
- LCD Brightness Adjust /
Low Battery Indicator _____ 20.
- Battery Replacement _____ 21.
- Specifcations _____ 22.
- Trouble Shooting _____ 23~24.
- Precaution _____ 24.
- General Specifications _____ 25.

English

Wheel Circumference Measurement

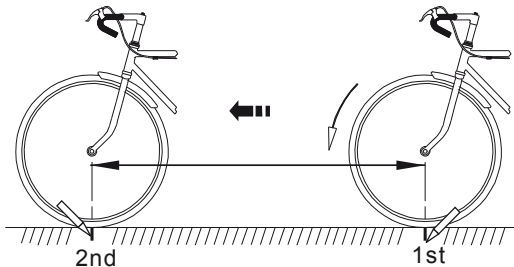

● Precise Measurement

Roll the wheel until the valve stem is at lowest point to the ground. Then mark this first point on the ground. Get on the bicycle and have a helper push you until the valve stem returns to lowest point. Mark the second point on the ground. Measure the distance between the marks. Enter this value to set the wheel circumference.

● Quick Table : Get a suitable circumference value from the table.

POPULAR TIRE CIRCUMFERENCE
REFERENCE TABLE

Tire Size	Circumference Number
18 Inch	1436 mm
20x1.75	1564
20 Inch	1596
22 Inch	1759
ATB 24x1.75	1888
24 Inch	1916
24x 13/8	1942
ATB 26x1.40	1995
ATB 26x1.50	2030
ATB 26x1.75	2045
26Inch (650A)	2073
ATB26x2.0(650B)	2099
700C TUBULAR	2117
700x20C	2092
700x23C	2112
700x25C	2124
700x28C	2136
27 Inch(700x32c)	2155
700x35C	2164
700x38C	2174
27.5 Inch	2193
28 Inch (700B)	2234
28.6 Inch	2281

Button function description

ALL CLEAR : **A+B+C** hold 3's (then automatically warm-up)

Enter fast pairing : **A+B+C** (in warm-up mode)

Enter clear eeprom : **A+B+C** hold 1's (in warm-up mode)

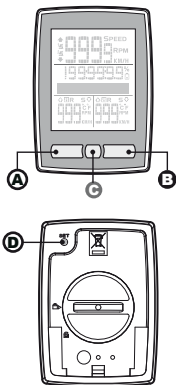

(1). Data setting mode:

A Button : Press for increase setting digital ,hold 1's for auto increase

B Button : Press for change setting digital

C Button : Press for enter next date setting mode

D Button : Press for quit date setting mode

(2). General mode:

A Button : Press for change function Group hold 1's for change screen display

B Button : Press for change function mode

C Button : Press for enter Lap and Lap review mode (for Ui35 only) : Hold 3's for turn on RF power (mount on bracket)

D Button : Press for enter data setting mode

A + B Button : Hold 3's for data reset

(3). Lap mode:

A Button : Press for start/stop Lap function

B Button : Press for change to next Lap

C Button : Press for enter Lap review mode

(4). Lap review mode:

A Button : Press for change Lap No.

B Button : Press for change Lap data

C Button : Press for to back general mode

A + B Button : Hold 3's for reset lap data

(5). When under maintenance mode:

A + B Button : Hold 3's for reset reminder to default value

Data setting

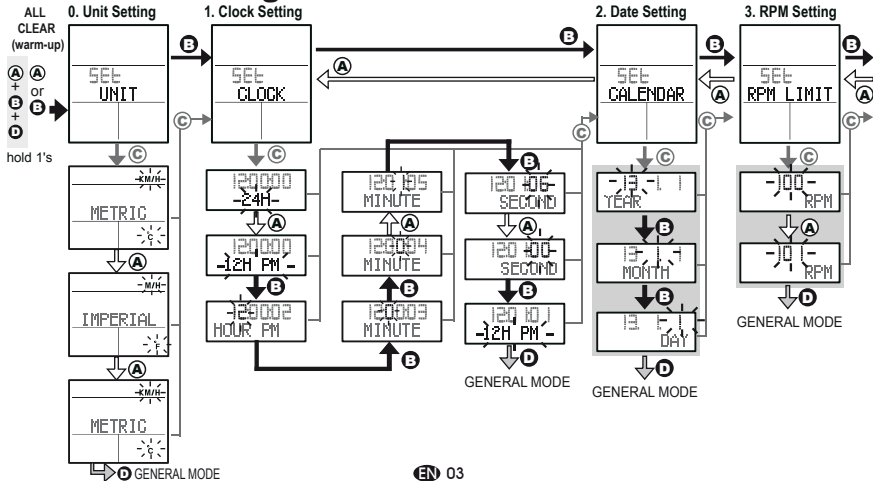

4. Bike1/Bike2 Setting



GENERAL MODE

5. Cmm 1/2 Setting

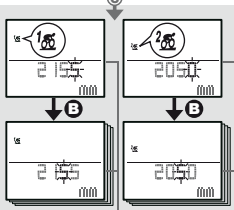

GENERAL MODE

6. Maintenance 1/2 Setting

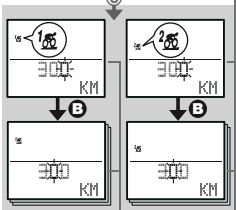

GENERAL MODE

7. ODO 1/2 Setting

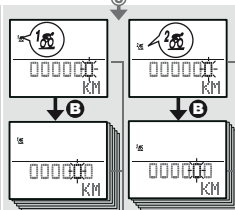

GENERAL MODE

8. T.RT 1/2 Setting

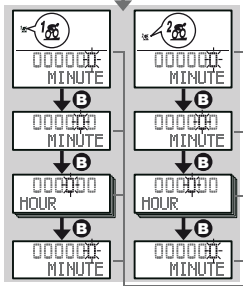

D → GENERAL MODE

9. Total Pedal Revolution 1/2 Setting

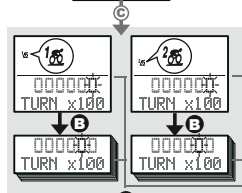
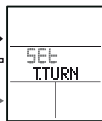

D ↓
GENERAL MODE

10. Total CO₂ Saving 1/2 Setting

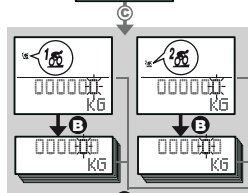
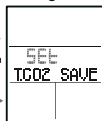

D ↓
GENERAL MODE

11. Sensor Pairing

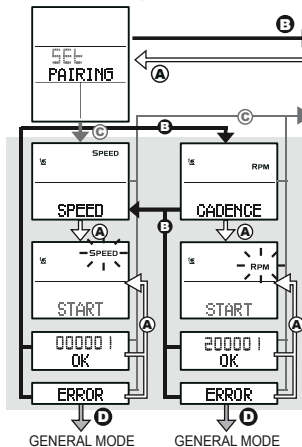

12. LCD Contrast Setting

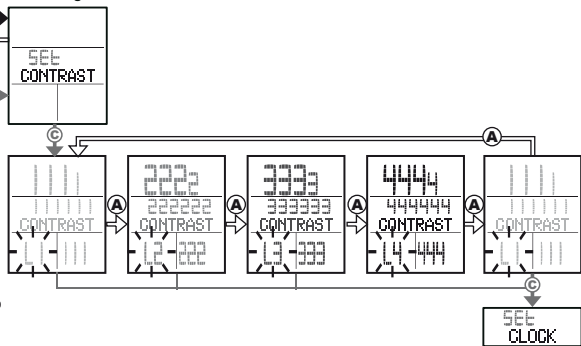

LCD (icon) display

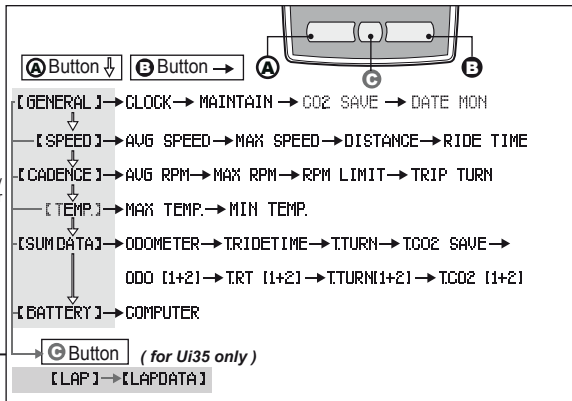
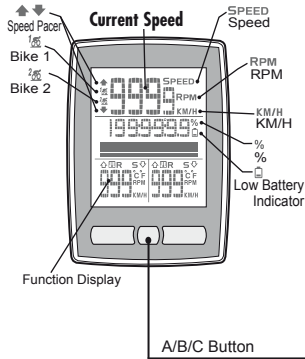

General Function Display

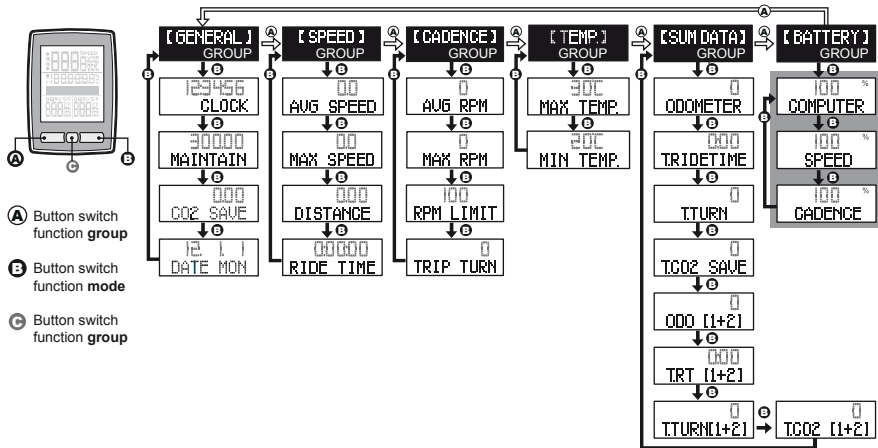

General Function Display (for Ui35 only)

A Button switch function group

B Button switch function mode

C Button switch function group

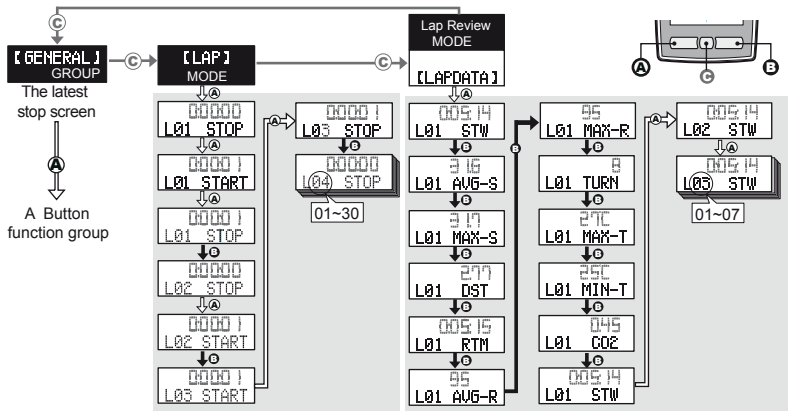

General Mode Display

The display of General Mode looks different in different phrases as shown below:

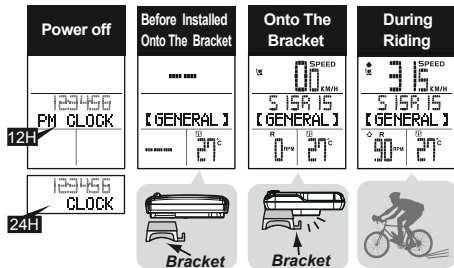

SPEED+RPM LCD Display

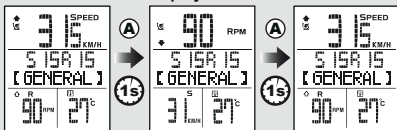

1. The main unit will automatically enter Sleep Mode in 15 minutes once it doesn't receive any signals from the bike. Only current time is displayed when the computer is in Sleep Mode (Power-Saving Mode.)
2. The computer will automatically start measuring the speed, cadence by put it onto the bracket, or by riding the bicycle if it was fit on the bracket already, or by pressing the A (or B) button to wake it up.
3. When you wake up the computer and riding, it will automatically scan for transmitters. S/R symbols will flash till coded. (S: Speed, R: RPM)
 - * If either of S/R symbol disappears, please hold C button 3 seconds. It will again automatically scan for transmitters.
4. When you put the computer onto the bracket, the display will turn to instant icon, press A (or B) will return to the function icon.
5. The computer will mark on the coded transmitter(s) only. Non-coded transmitter(s) will result in non-instant data display.

Note:

- * All the computer and transmitter in the package had been paired in the factory before shipment. You might to pair them again when: 1. no signal received, 2. buy or replace with new parts.
- * The computer can keep sensor pairing data in the memory even you change the battery.

Sensor pairing

When you have all the bracket, transmitters, and accessories installed, you need to do the pairing and coded signal testing between computer and transmitters.

1. Hold 1 second button D, it will enter setting loop, press D button to find the SENSOR PAIRING, choose bike1 or bike 2 (by pressing B) and press A to show coded ID. If computer did not receive any signal from transmitter over 30 seconds, it will show TIME OUT; please check the installation, battery power, and do the pairing again.
2. This computer is design for 2 bikes (you could purchase the 2nd set bike parts), it will automatically shift to bike 1 or bike 2 after pairing separately.

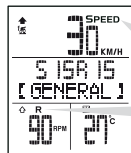

SPEED SPEED signal received

RPM RPM signal received

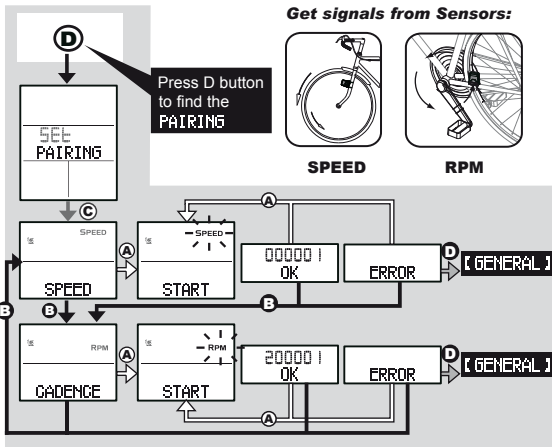

Functions

SPEED FUNCTIONS

[SPEED]	Speed
-----------	-------

1. The current speed is always shown on the middle display during riding.
2. The speed data are updated per second.

AVG SPEED	Average Speed
-----------	---------------

1. With this function, the computer will display your average speed during riding.
2. Whenever you reset the computer or change the battery, the average speed record will be cleared.
3. The computer will automatically reset the following data to zero once the riding time is over 100 hours or the distance is over 1000KM (or miles): Riding Time, Trip Distance, Average Speed.

MAX SPEED	Maximum Speed
-----------	---------------

1. With this function, the computer will record the maximum speed you reach during riding.
2. Whenever you reset the computer or change the battery, the max. speed record will be cleared.

DISTANCE	Trip Distance
----------	---------------

1. Trip distance refers to the accumulated distance during a trip.
2. Whenever you reset the computer or change the battery, the trip distance record will be cleared.

ODOMETER	Odometer
----------	----------

1. With this function, the computer accumulates the total distance of the bike you ride.
2. The odometer data cannot be cleared by the reset operation.

ODO [1+2]	Total odometer (Bikes 1+2)
-----------	------------------------------

1. With this function, the computer accumulates the total distance of the two bikes you ride.
2. The sum of ODO 1 and ODO 2 equals ODO (1) (2). (i.e. total distance of bikes 1 and 2)
3. The total odometer data cannot be cleared by the reset operation.

SPEED FUNCTIONS

RIDE TIME	Trip Riding Time
-----------	------------------

1. Riding time refers to the accumulated riding time of a trip.
2. Whenever you reset the computer or change the battery, the trip distance record will be cleared.
3. The computer automatically starts measuring the riding time upon receipt of wheel signals.

TRIDETIME	Total Riding Time
-----------	-------------------

1. With this function, the computer accumulates the total riding time of a bike.
2. The total riding time data cannot be cleared by the reset operation.



T.RT [1+2]	Total Riding Time (Bikes 1+2)
------------	---------------------------------

1. With this function, the computer accumulates the total riding time of the two bikes you ride.
2. The sum of T_RIDINGTIME bike 1 and bike 2 equals A_RIDINGTIME. (i.e. total riding time of bikes 1 plus 2)
3. The accumulated total riding time of Bike 1 and Bike 2 cannot be cleared by the reset operation.

MAINTAIN	Maintenance
----------	-------------

1. function is to remind you about maintaining your beloved bike after presetting the desired reminding distance.
2. It displays the icon (MAINTAIN) for Maintenance Reminder setting. (Maintenance: Bike1:300km or miles, Bike2:990km or miles.)

 	Speed Pacer
---	-------------

1. The pace arrow shows the comparison between the current speed and average speed.
2. If the current speed is above or equal to the average speed, the upward arrow () will flash on the display.
3. On the contrary, if the current speed is below the average speed, the downward arrow () will flicker.

RPM FUNCTIONS

[CADENCE]	RPM
-------------	-----

1. RPM (Revolutions Per Minute) is a measure of rotational speed. It's updated every second.
2. The current RPM (cadence) is always shown on the middle display.
3. For Bike 1, if you do not turn the crank for over 4 seconds, the current RPM will be reset to zero.
For Bike 2, if you do not turn the crank for over 2 seconds, the current RPM will be reset to zero.

MAX RPM	Maximum RPM
---------	-------------

1. With this function, the computer will record your maximum cadence during riding.
2. Whenever you reset the computer or change the battery, the max. RPM record for a trip will be cleared.

AUG RPM	Average RPM
---------	-------------

1. With this function, the computer will display the average cadence during riding. It's updated per second.
2. Whenever you reset the computer or change the battery, the average cadence record will be cleared.

TRIP TURN	Trip Pedal Revolution
-----------	-----------------------

1. The bike1, bike2 accumulates the pedal revolutions as long as the bike is running.
2. The bike1, bike2 data can be cleared to zero by Data Reset operation.

RPM LIMIT	RPM limit
-----------	-----------

Setup the RPM value, the pacer symbol will show up (beep should sound) to remind you only when RPM is over limit. By this way you can shift to a upper gear for more easy riding.

T.TURN	Total Pedal Revolution
--------	------------------------

1. The computer accumulates the total pedal revolutions as long as the bike is running.
2. The bike1, bike2 data can not be cleared to zero by Data Reset operation, but by all clear operation.
3. The real value is ten times of the number on the screen. (ex. 38, means 380 turns)

RPM FUNCTIONS

T.TURN[1+2]	Total Pedal Revolution (Bikes 1+2)
-------------	--------------------------------------

1. The A-revolution accumulates the total pedal revolutions as long as the bike is running. Either Bike 1 or 2 has its individually.
A-revolution is the sum after bike1 plus bike2 total pedal revolutions
2. The A-revolution data can not be cleared to zero by Data Reset operation, but by all clear operation.
3. The real value is one hundred times of the number on the screen. (ex. 188, means 18800 turns)

RPM Limit Pacer

A pacer symbol will show up to remind you only when RPM is over limit (beep should sound). By this way you can shift to a upper gear for more easy riding.

TEMPERATURE FUNCTIONS

[TEMP.]	Current Temperature
---------	---------------------

Temperature would be automatically detected under this mode. You could choose either in °C or °F to display the temperature.

MAX / MIN TEMP.	Maximum / Minimum Temperature
-----------------	-------------------------------

1. With this function, the computer will display the Maximum temperature / Minimum temperature during riding.
2. Whenever you reset the computer or change the battery, the Maximum temperature / Minimum temperature record will be cleared.

CO₂ FUNCTIONS

T.CO ₂ SAVE	Trip CO ₂ Saving
------------------------	-----------------------------

The CO₂ function accumulates the CO₂ saving amount from the last RESET operation as long as the bike is being ridden.

T.CO ₂	Total CO ₂ Saving
-------------------	------------------------------

The Total CO₂ Saving as long as the bicycle is running, the CO₂ saving can be cleared by the All Clear operation only.

CO₂ FUNCTIONS

T.CO ₂ (1+2)	Total CO ₂ Saving (Bikes 1+2)
-------------------------	--

1. With this function, the computer accumulates the total CO₂ Saving of the two bikes you ride.
2. The sum of T.CO₂ Bike1 and T.CO₂ Bike2 equals T.CO₂ Bike1+Bike2.
3. The total CO₂ saving cannot be cleared by the reset operation.

OTHERS FUNCTIONS

CLOCK	Clock Time: 12H/24H Alternative
-------	---------------------------------

1. When the user sets the clock time in Data Setting Mode, there are two formats for option-- 12H and 24H.
2. 12H means 12 hours. In this format, to AM or PM. 24H means 24 hours.
3. When in the sleep mode, only the clock time will be displayed on the screen.

CALENDAR	Calendar
----------	----------

1. Calendar per setting month /day /year
2. auto display day format 01.01.2013~12.31.2099.

UNIT	Unit Selection
------	----------------

Press MODE button (A) to choose KM/H or M/H. Then press the SET button (D) to store selection.

OTHERS FUNCTIONS

WHEELSIZE

Circumference

1. Roll the wheel until the valve stem at its lowest point close to the ground, then mark this first point on the ground.
2. Measure the distance between the marks in millimeters. Enter this value to set the wheel circumference.
Option: Get a suitable circumference value from the table.
3. Adjust the wheel circumference as the data setting process.
4. Unit will change to the normal operation after this circumference setting.

LEVEL

Lcd Brightness Adjust

- 4 grades adjust the brightness.
To reset it you need to pull off the computer from the bracket. Hold the C button to enter setting mode, Hold the A button find the BRIGHTNESS SETTING.



Low Battery Indicator

1. When the low-battery icon "  " appears on the display, it's time to get a new battery.
2. Replace the battery with a new one when the icon blinks on the display. Otherwise, the new data of some functions will not be stored into the computer.

Auto Detect (Bike1 / Bike2)

This computer is design for 2 bikes (you could purchase the 2nd set bike parts), it will automatically shift to bike 1 or bike 2 after pairing separately.

Auto Start / Stop

To preserve battery, this computer will automatically switch off and just displays the CLK data when it has not been used for about 15 minutes.
The power will be turned on automatically by riding the bike or by pressing the button.

Maintenance Reminder

maintenance default value

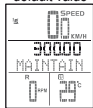

after ride 312.37km,
over counting 12.37km.

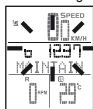

reset reminder to
default value

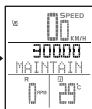

MAINTENANCE REMINDER

1. The user's friendly function is to remind you about maintaining your beloved bike after presetting the desired reminding distance.
2. It displays the icon for Maintenance Reminder setting.

About Pedal Revolution



The REVOLUTION function accumulates the pedal rotation data from the latest RESET operation as long as the bicycle is being ridden.

T.TURN

1. The computer accumulates the total pedal revolutions as long as the bike is running.
2. The real value is 100 times of the number on the screen. (ex. 38, means 3800 turns)
3. Computer will keep this data even you change the battery.

T.TURN(1+2)

1. T.TURN(1+2) is the sum of bike1 and bike2 of its total pedal revolution.
2. The real value is 100 times of the number on the screen. (ex. 38, means 3800 turns)
3. Computer will keep this data even you change the battery.

About RPM Limit

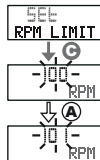

1. A pacer symbol will show up to remind you only when RPM is over limit. By this way you can shift to a upper gear for more easy riding.
2. To rest it you need to pull off the computer from the bracket. Find "RPM limit" icon (cadence group), hold 1 second the D button to enter (quit) setting mode.

About LAP (for Ui35 only)

	Lap Data Group			
	L01 STW	L01 AVG-S	L01 MAX-S	L01 DST
	L01 RTM	L01 AVG-R	L01 MAX-R	L01 TURN
L01 MAX-T	L01 MIN-T	L01 CO2		

With LAP function, you can have the trip or training divided into several (up to 30) records.

1. Press C to find the LAP icon, press Start to record a new Lap.
2. Lap review is allowed only when you stop riding.
3. In Lap Data Group
Speed (AVERAGE / MAXIMUM / DISTANCE / RIDE TIME)
RPM (AVERAGE / MAXIMUM / REVOLUTION)
4. 31st Lap record will automatically cover the 1st Lap record.
5. To clear the LAP data, LAP function group icon, hold 3 seconds A and B button.

LAP DATA RESET

Lap data can be cleared only in the LAP icon (LAP mode.)

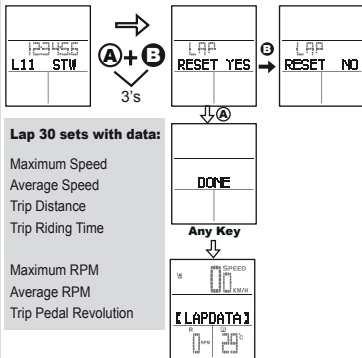

LCD Brightness Adjust

4 grades adjust the brightness.

To reset it you need to pull off the computer from the bracket.

Hold 1 second the D button to enter setting mode, find the CONTRAST SETTING.

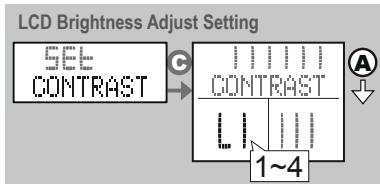

LCD 4 grades brightness

	2222	3333	4444
CONTRAST	CONTRAST	CONTRAST	CONTRAST
L1	L2 222	L3 333	L4 444

Low Battery Indicator

Battery status detects (batteries in computer and in transmitters):

If you do not change the battery in a few hours, the computer may still work for a few days. The data will be displayed as usual, but the new data will not be stored before the battery is changed.

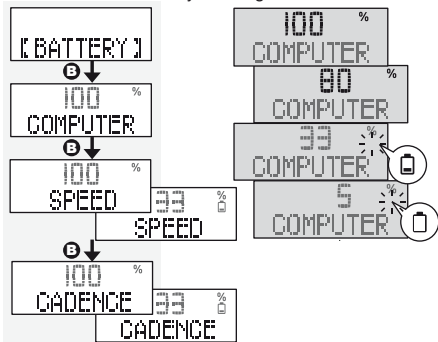

Battery Replacement

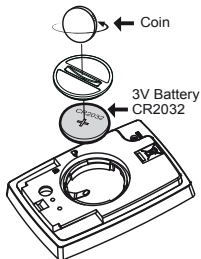

Check battery power status in BATT icon.
Please change battery if the empty battery symbols show up, low power will result in stopping data record.

[GENERAL] CLOCK / MAINTAIN /
CO2 SAVE / DATE MON
[CADENCE] RPM LIMIT
[SUM DATA] ODOMETER / TRIDETIME
T.TURN / T.CO2 SAVE
ODO [1+2] / TRT [1+2]
T.TURN[1+2] / T.CO2 [1+2]

Main unit battery change

1. Replace the battery with a new battery within a few days when the symbol appears."  "
2. Replace with a new CR2032 battery and initiate the main unit.

Speed (RPM) Transmitter Battery Change

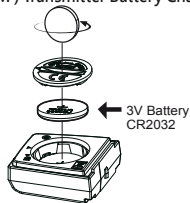

Speed and RPM transmitter Battery change

1. The patent-pending transmitter circuit is designed to reduce power consumption, please use a 3V battery for transmitter (generally a CR2032).
2. Replace a new battery when the transmitter's battery power is nearly exhausted, otherwise the transmission power will be very weak and unstable data display will occur.
3. Replace a new CR2032 battery with the positive (+) pole toward the sensor cap .

Specifications

Functions	Specifications
Current Speed	0-199.9 KM/H 0-120.0 M/H
Average Speed	0-199.9 KM/H 0-120.0 M/H
Maximum Speed	0-199.9 KM/H 0-120.0 M/H
Trip Distance	0-999.99 KM/MILE
Odometer	0-999999 KM/MILE
Total Odometer (Bike1+Bike2)	0-1999999 KM/MILE
Trip Riding Time	00H00M00S-99H59M59S
Total Riding Time	00H00M-9999H59M
Total Riding Time(Bike1+Bike2)	0-19999H59M
Maintenance	0-999 KM/MILE
Speed Pacer	Compare With Average Speed
Current RPM	0-199 RPM
Average RPM	0-199 RPM
Maximum RPM	0-199 RPM
Trip Pedal Revolution	0-999999 RPM
RPM Limit	10-199 RPM
Total Pedal Revolution	0-999999*100 RPM
Total Pedal Revolution(Bike1+Bike2)	0-1999999*100 RPM
RPM Limit Pacer	Compare With RPM Limit
Current Temperature	-10 ~ 60°C 14~140°F
Maximum Temperature	-10 ~ 60°C 14~140°F

Functions	Specifications
Minimum Temperature	-10 ~ 60°C 14~140°F
Trip CO2 Saving	0-999.99 KG/LB
Total CO2 Saving	0-999.99 KG/LB
Total CO2 Saving (Bike1+Bike2)	0-999.99 KG/LB
Lap Data Review	
Stopwatch	0H00M00S-99H59M59S
Speed(Average/Maximum)	0-199.9 KM/H 0-120.0 M/H
Trip Distance	0-999.99 KM/MILE
Riding Time	0H00M00S-99H59M59S
RPM(Average/Maximum)	0-199 RPM
Pedal Revolution	999999 RPM
CO2 saving	0-999.99 KG/LB
Temperature(Maximum/Minimum)	-10 ~ 60°C 14~140°F
12H/24H Clock	0H00M00S-23H59M59S/1H00M00S-12H59M59S
Calendar	2013-2099
Unit Selection	Km , Mile
Circumference	0-3999 mm
Lcd Brightness Adjust	L1~L4
Low Battery Indicator	<2.6V
Auto Detect (Bike1+Bike2)	
Auto Start/Stop	1's on , 119's off

Trouble Shooting

PROBLEM	CHECK ITEMS	REMEDY
No display	<ol style="list-style-type: none"> 1. Is the battery dead ? 2. Is there incorrect battery installation ? 	<ol style="list-style-type: none"> 1. Replace the battery. 2. Be sure that the positive pole of the battery is faces the battery cap.
No current Speed or incorrect data	<ol style="list-style-type: none"> 1. Does the Speed symbol disappear ? 2. Is it at the main unit data setting display ? 3. Are the contacts between the main unit and the bracket poor ? 4. Are the relative positions and gap of speed transmitter and magnet correct ? 5. Is the circumference correct ? 	<ol style="list-style-type: none"> 1. Please hold C button 3 seconds; it will again automatically scan for transmitters. Or refer to Sensor Pairing. 2. Refer to the main unit data setting procedure and complete the data setting. 3. Wipe contacts clean. 4. Re-adjust position and gap correctly. 5. Refer to P.1 and enter correct value.
No current RPM or Incorrect data	<ol style="list-style-type: none"> 1. Does the RPM symbol disappear ? 2. Is the relative positions and gap between RPM transmitter and magnet correct ? 3. Is the sensing distance too long or the installation angle of the RPM transmitter incorrect ? 4. Is the RPM transmitter battery nearly exhausted ? 5. Is any strong interference source nearby ? Irregular display 	<ol style="list-style-type: none"> 1. Please hold C button 3 seconds; it will again automatically scan for transmitters. Or refer to Sensor Pairing p.11. 2. Re-adjust position and gap correctly. 3. Adjust distance or angle between the main unit and the RPM transmitter. 4. Repair with a new battery. 5. Move away from the source of interference.

Irregular display		Refer to the "Main unit data setting" and initiate the main unit again.
LCD is black	Have you left main unit under direct sunlight when not riding the bike for a long time ?	Place main unit in the shade to return to normal state. No adverse effect on data.
Display is slow	Is the temperature below 0°C (32°F) ?	Unit will return to normal state when the temperature rises.

Precaution

1. Remember to pay attention to the road while riding.
2. Don't disassemble the main unit or its accessories.
3. Check relative position and gap of sensor, magnet and main unit periodically.
4. Don't use thinner, alcohol or benzene to clean the main unit or accessories when they are dirty.
5. Don't leave the main unit exposed to direct sunlight when not riding the bike.
6. Take care of you chest belt. Wash the chest belt by suds, and then flush out with water. Let it dry naturally. Avoid putting the chest belt under the environment of high temperature or touching the corrosive material such strong acid or alkalis .
7. The physical condition of individual might effect the intensity of signal.
8. Avoid using the heart rate close to trolley car, tram stop, transformer, electric substation and high-tension distribution line, etc. Because the radio signal will be affected under the environment with high voltage and strong magnetic field.
9. To ensure your safety, please use the Heart Rate Transmitter under a doctor or coach's direction if you have one of the following conditions:
 - a. Cardiopulmonary disease
 - b. Obesity.
 - c. No exercise for long period of time.

General Specifications

Operating Temperature:	0°C - 50°C (32°F - 122 °F)
Storage Temperature:	-10°C - 60°C (14°F - 140°F)
Sensor & Transmitter:	No-contact magnet sensor with wireless transmitter
Suitable Fork Sizes:	12 mm - 50 mm (0.5" - 2.0")
Battery:	CR2032
Dimensions & Weight:	Main Unit: 58.6 x 42.6 x 15.6mm / 29.0g Speed / RPM transmitter: 39.4 x 37.6 x 14.85mm / 15.0g